

## **JØVA Beslag A/S**

Telefon +45 8617 2122

[www.joeva.dk](http://www.joeva.dk)

email: [info@joeva.dk](mailto:info@joeva.dk)



2019

## Tætningslister

# TÆTNINGSLISTER

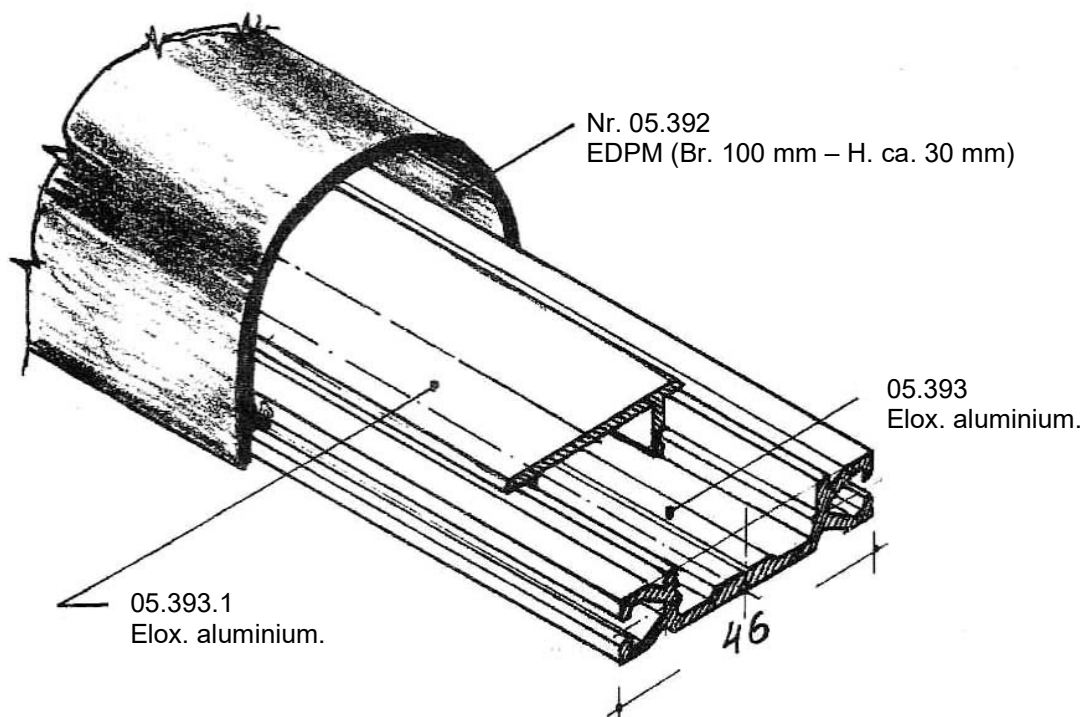

Nr. 05.350

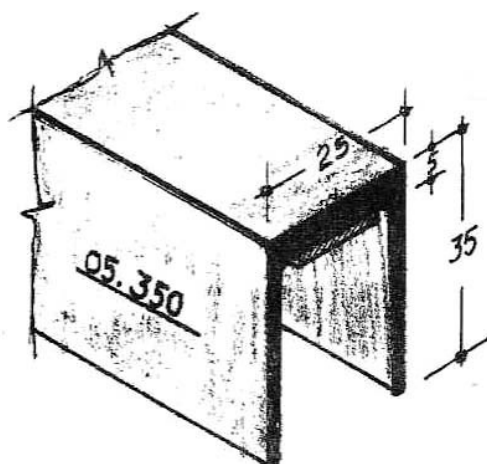

Nr. 05.349

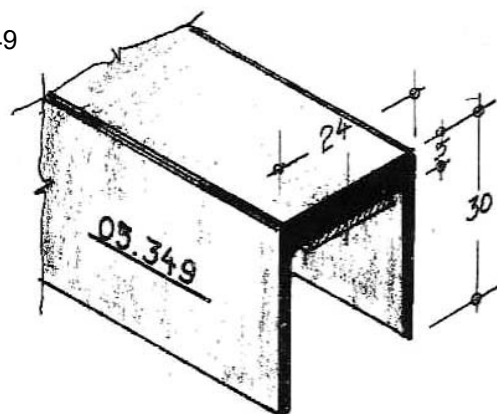

EPDM lister  
Vist med kunststofliste  
05.430.14 – 14 x 2 mm.

Nr. 05.394  
EPDM gummi/eloxeret aluminiumsprofil

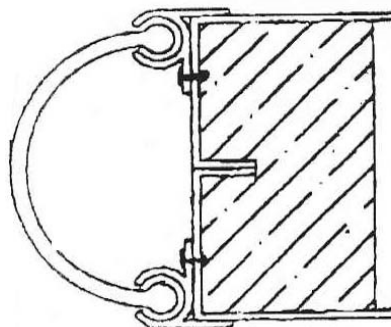

Til montering på  
40mm svingdøre

# TÆTNINGSLISTER

## Svampe gummi profil

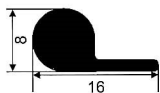

Nr. 05.341

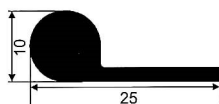

Nr. 05.345

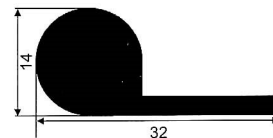

Nr. 05.352

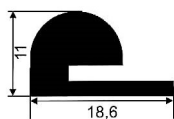

Nr. 05.339

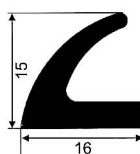

Nr. 05.336

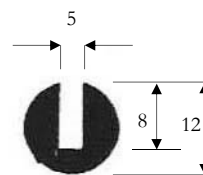

Nr. 05.344

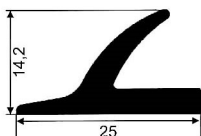

Nr. 05.340

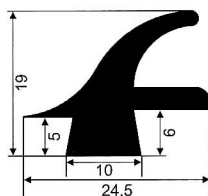

Nr. 05.337

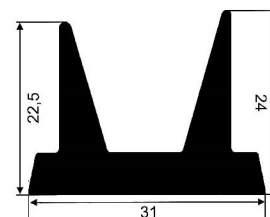

Nr. 05.338

## Svampegummi med hvidt lærred

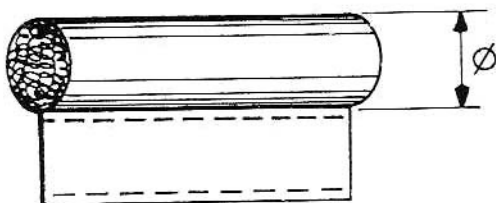
Nr. 05.108  $\varnothing = 8,0$  mmNr. 05.110  $\varnothing = 10,0$  mmNr. 05.112  $\varnothing = 12,0$  mm

Flange = 10 mm.

## Svampegummiprofil

- 6 x 8 mm
- 10 x 3 mm
- 10 x 5 mm
- 10 x 7 mm
- 10 x 10 mm
- 10 x 12 mm

# TÆTNINGSLISTER

Plastik profil

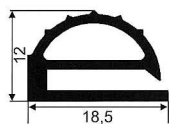

Nr. 05.212

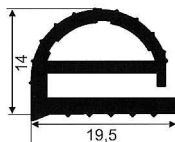

Nr. 05.211

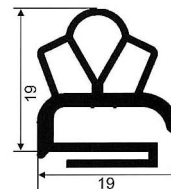

Nr. 05.276

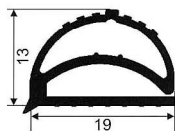

Nr. 05.213

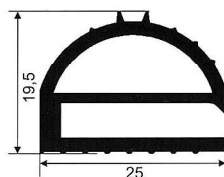

Nr. 05.210

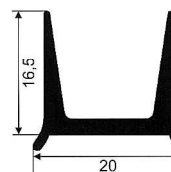

Nr. 05.360

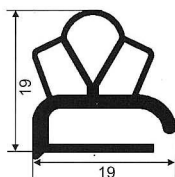

Nr. 05.275

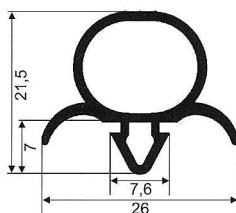

Nr. 05.277

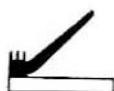

Nr. 05.225

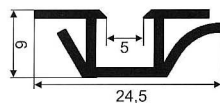

Nr. 05.278

Kan leveres i færdige rammer med svejste hjørner (undtagen profil nr. 05.225 + nr.05.278)

## **VIGTIGT VED BESTILLING AF SVEJSTE LISTER!**

Lister til spor (05.277) opgives mål fra midt/midt spor.

Øvrige lister opgives udvendigt mål.

**OBS! FÆRDIGE SVEJSTE RAMMER TAGES IKKE RETUR!!!**

# TÆTNINGSLISTER

Plastik profil

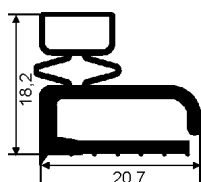

Nr. 05.214

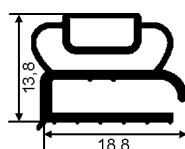

Nr. 05.270

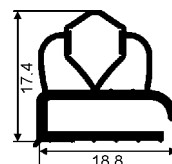

Nr. 05.270A

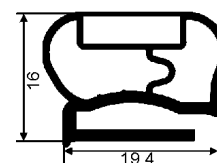

Nr. 05.280

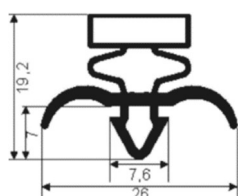

Nr. 05.274

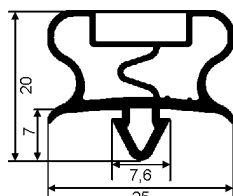

Nr. 05.279

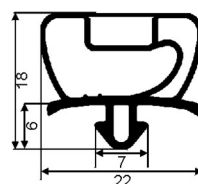

Nr. 05.281

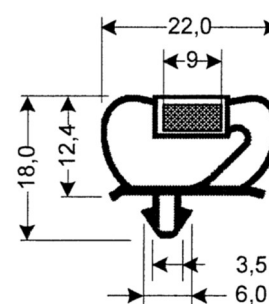

Nr. 05.289

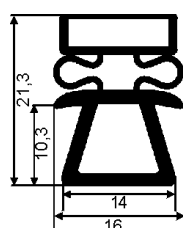

Nr. 05.273

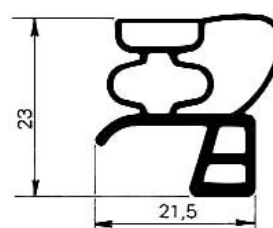

Nr. 05.286

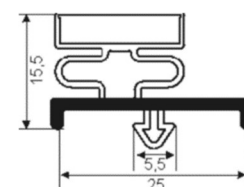

Nr. 05.282

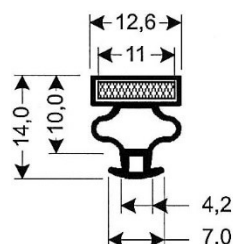

Nr. 05.283

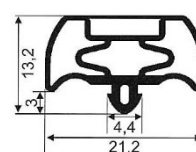

Nr. 05.287

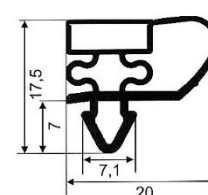

Nr. 05.288

Kan leveres i færdige svejste rammer.  
Med magnet i 3 sider, kan A profilerne anvendes i hængselsiden.

## VIGTIGT VED BESTILLING AF SVEJSTE LISTER!

Lister til spor (05.273, 05.274, 05.282, 05.279, 05.289, 05.281, 05.283, 05.286, 05.287 og 05.288) opgives mål fra midt/midt spor.

Øvrige lister opgives udvendigt mål.

**OBS! FÆRDIGE SVEJSTE RAMMER OG PLASTIC PROFILER SOLGT I METER MÅL  
TAGES IKKE RETUR!!!**

# TÆTNINGSLISTER

Plastik profil

30-M

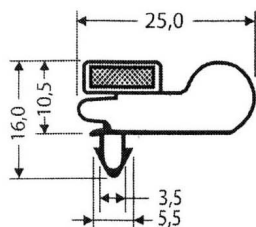

31-M

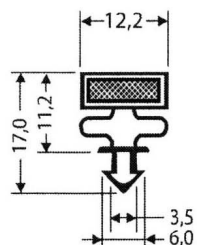

38-M

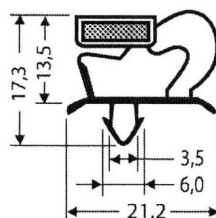

33-M

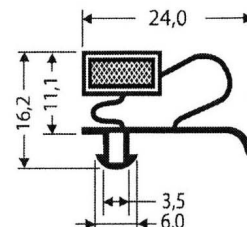

70-M

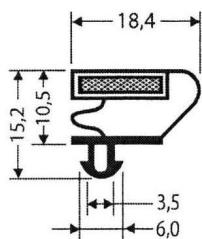

74-M

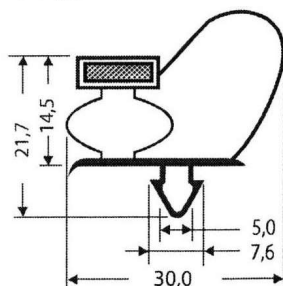

79-M

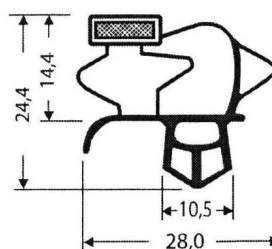

75-M

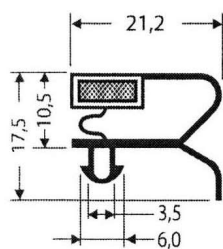

76-M

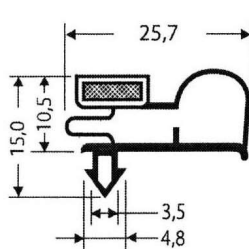

Kan leveres i færdige svejste rammer.

## VIGTIGT VED BESTILLING AF SVEJSTE LISTER!

Lister til spor opgives mål fra midt/midt spor.

**OBS! FÆRDIGE SVEJSTE RAMMER OG PLASTIC PROFILER SOLGT I METER MÅL  
TAGES IKKE RETUR!!!**

# TÆTNINGSLISTER

Plastik profil

80-M

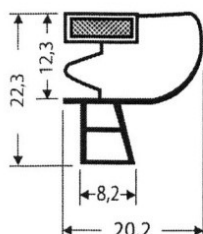

81-M

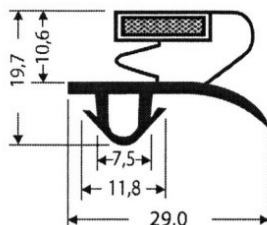

82-M

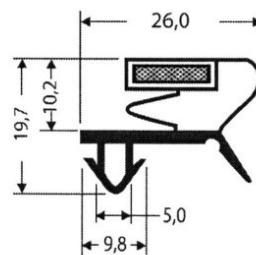

83-M

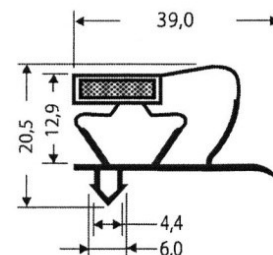

111-M

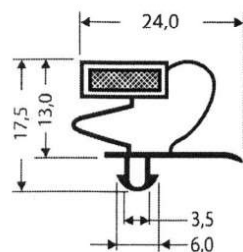

112-M

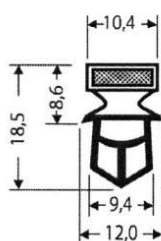

114-M

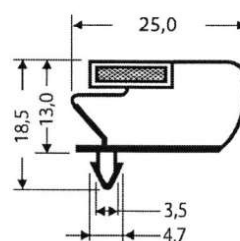

115-M

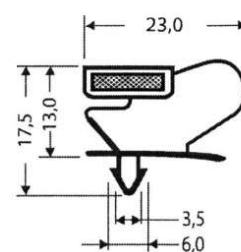

118-M

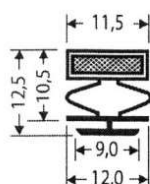

119-M

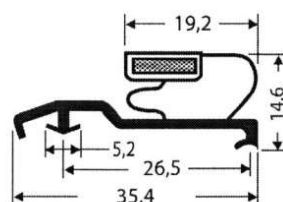

124-M

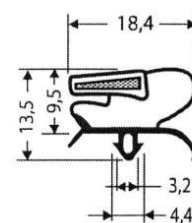

170-M

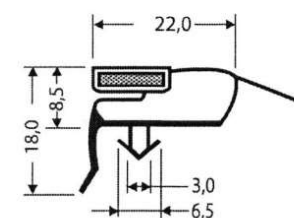

129-M

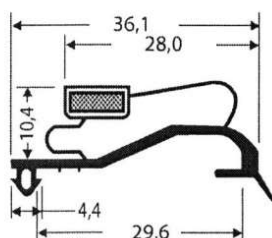

132-M

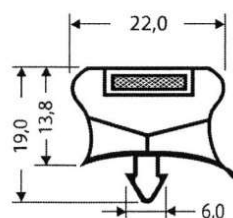

162-M

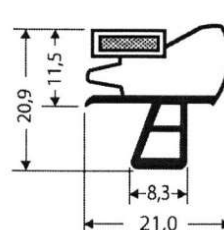

Kan leveres i færdige svejste rammer.

## VIGTIGT VED BESTILLING AF SVEJSTE LISTER!

Lister til spor opgives mål fra midt/midt spor.

**OBS! FÆRDIGE SVEJSTE RAMMER OG PLASTIC PROFILER SOLGT I METER MÅL  
TAGES IKKE RETUR!!!**

# TÆTNINGSLISTER

Plastik profil

171-M

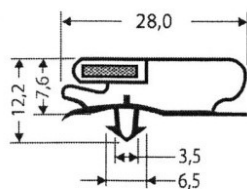

173-M

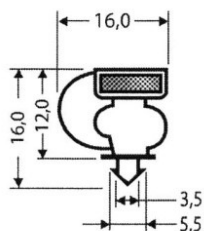

177-M

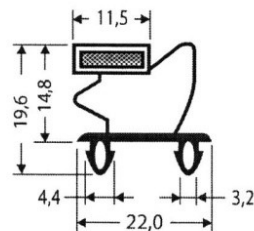

179-M

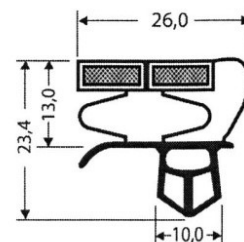

180-M

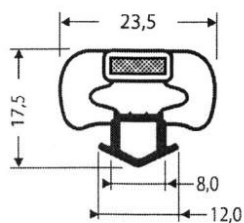

301-M

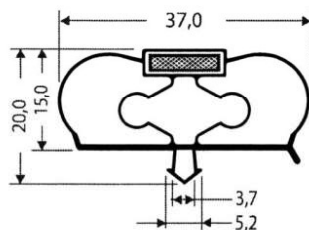

296-M

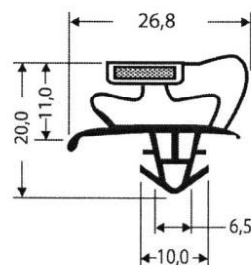

298-M

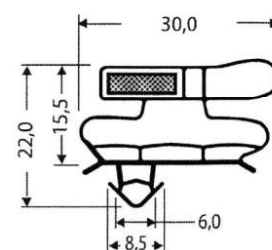

299-M

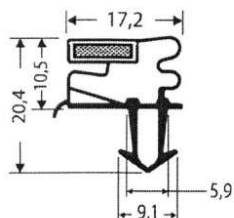

337-M

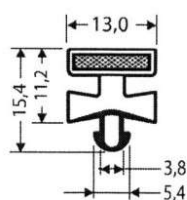

Kan leveres i færdige svejste rammer.

## VIGTIGT VED BESTILLING AF SVEJSTE LISTER!

Lister til spor opgives mål fra midt/midt spor.

**OBS! FÆRDIGE SVEJSTE RAMMER OG PLASTIC PROFILER SOLGT I METER MÅL  
TAGES IKKE RETUR!!!**



# TÆTNINGSLISTER

Plastik profil

21-A

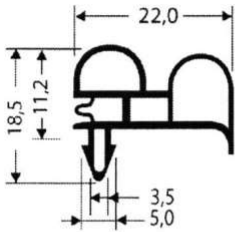

22-A

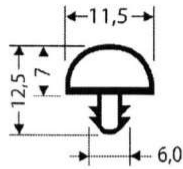

24-A

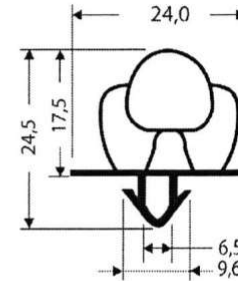

27-A

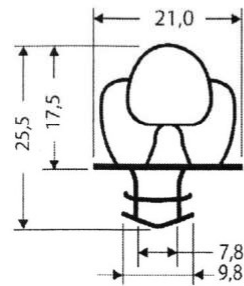

28-A

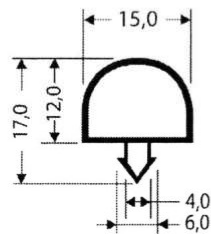

30-A

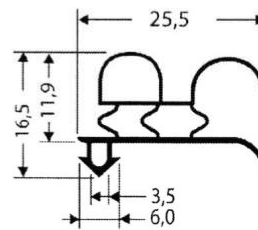

30-R

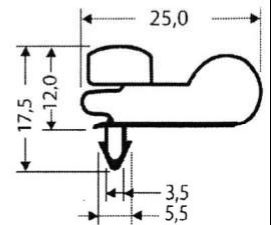

172-A

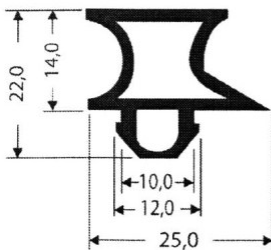

172-B

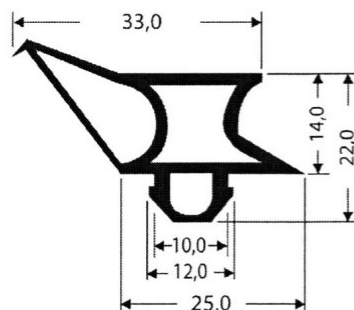

Kan leveres i færdige svejste rammer.

## VIGTIGT VED BESTILLING AF SVEJSTE LISTER!

Lister til spor opgives mål fra midt/midt spor.

**OBS! FÆRDIGE SVEJSTE RAMMER OG PLASTIC PROFILER SOLGT I METER MÅL  
TAGES IKKE RETUR!!!**

# TÆTNINGSLISTER

Plastik profil

16- 105-M

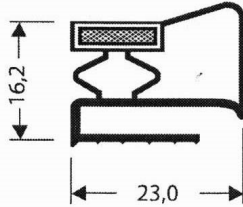

121-M

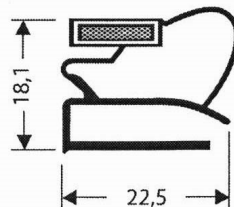

39-M

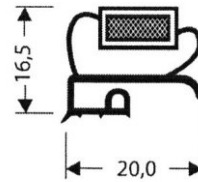

46-M

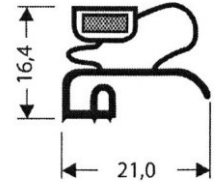

66-M

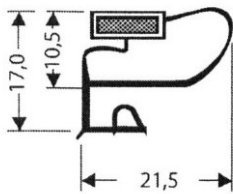

205-M

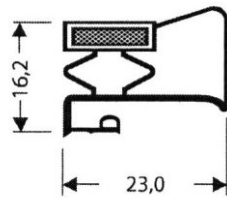

Kan leveres i færdige svejste rammer.

## VIGTIGT VED BESTILLING AF SVEJSTE LISTER!

Udvendigt mål opgives.

**OBS! FÆRDIGE SVEJSTE RAMMER OG PLASTIC PROFILER SOLGT I METER MÅL  
TAGES IKKE RETUR!!!**

# TÆTNINGSLISTER

Gummi profil mål 1:1  
EPDM

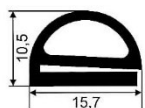

Nr. 05.310

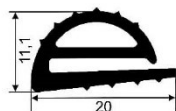

Nr. 05.314

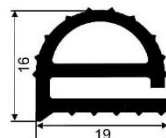

Nr. 05.312

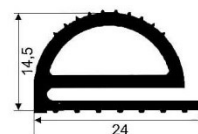

Nr. 05.313

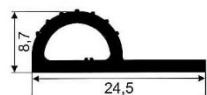

Nr. 05.311

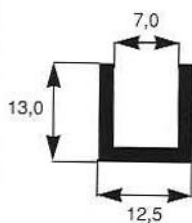

Nr. 05.316

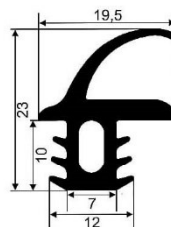

Nr. 05.347

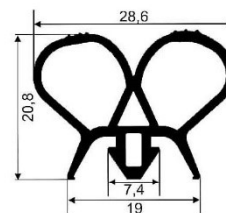

Nr. 05.348

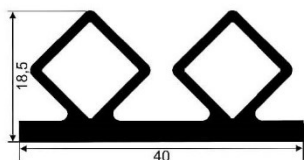

Nr. 05.346

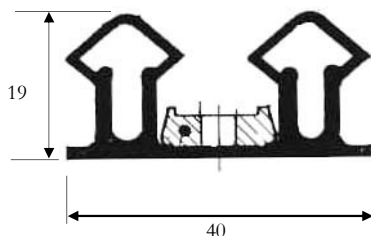

Nr. 05.342

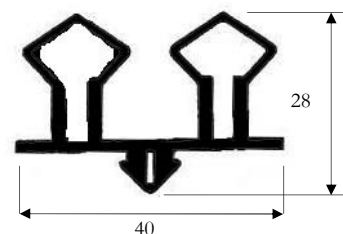

Nr. 05.342.1

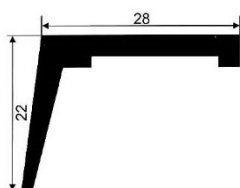

Nr. 05.351

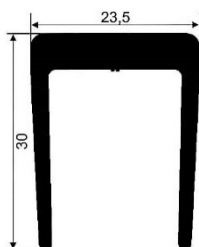

Nr. 05.349

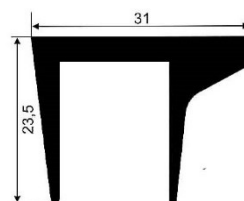

Nr. 05.370

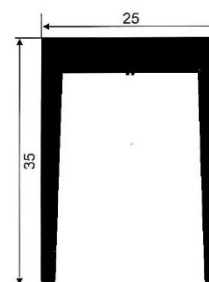

Nr. 05.350

# TÆTNINGSLISTER

Silikone gummi profil mål 1:1



Nr. 05.223



Nr. 05.220.3



Nr. 05.224



Nr. 05.220.4



Nr. 05.220.5



Nr. 05.220.6



Nr. 05.220.7

# TÆTNINGSLISTER

Silikone gummi profil mål 1:1. Temperaturområde – 65°C + 210°C



Nr. 05.232



Nr. 05.230



Nr. 05.233



Nr. 05.231



Nr. 05.235



Nr. 05.234



Nr. 05.238



Nr. 05.239

# TÆTNINGSLISTER

Gummiprofil mål 1:1

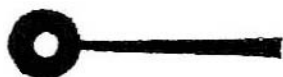

Nr. 05.307



Nr. 05.308



Nr. 05.309

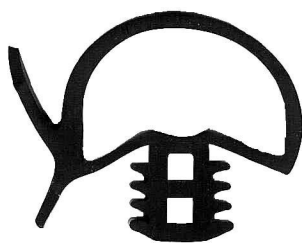

Nr. 05.425



Nr. 05.426



Nr. 05.427

# TÆTNINGSLISTER

Gummi profil  
EPDM

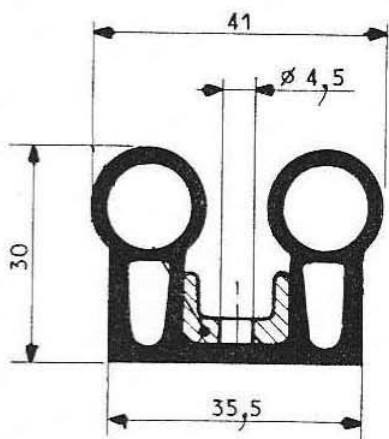

Nr. 05.355

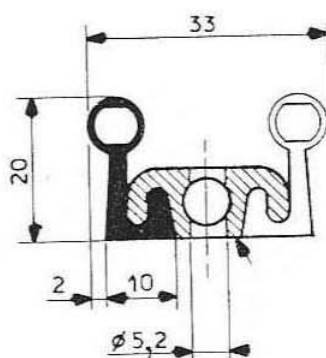

Nr. 05.356

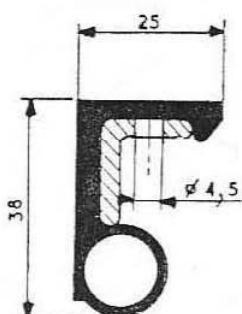

Nr. 05.358

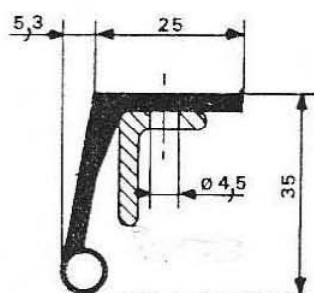

Nr. 05.359

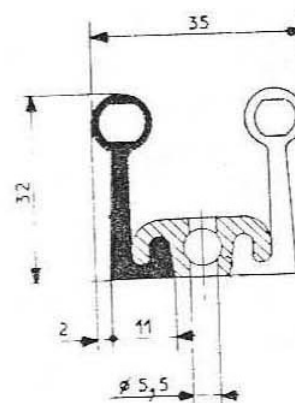

Nr. 05.357

Plastic profil:

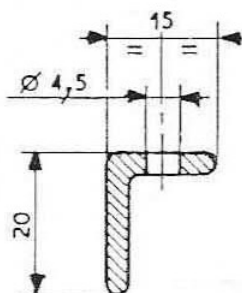

Nr. 05.295

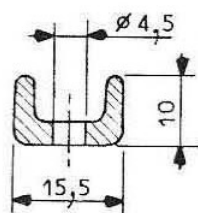

Nr. 05.296

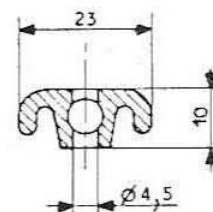

Nr. 05.297

# BØRSTETÆTNING

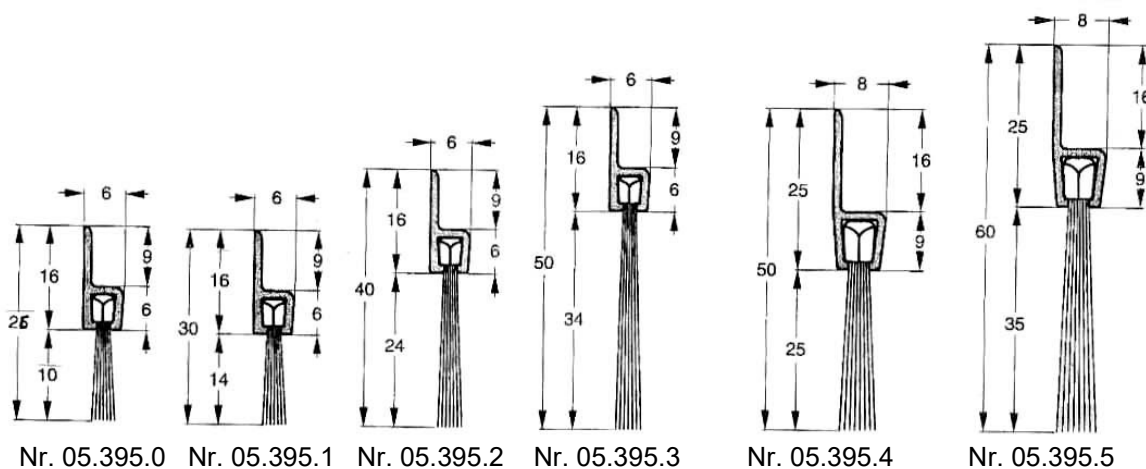

Aluminiumsprofil med sorte nylon børster

Alle størrelser kan leveres i 45° og 90°

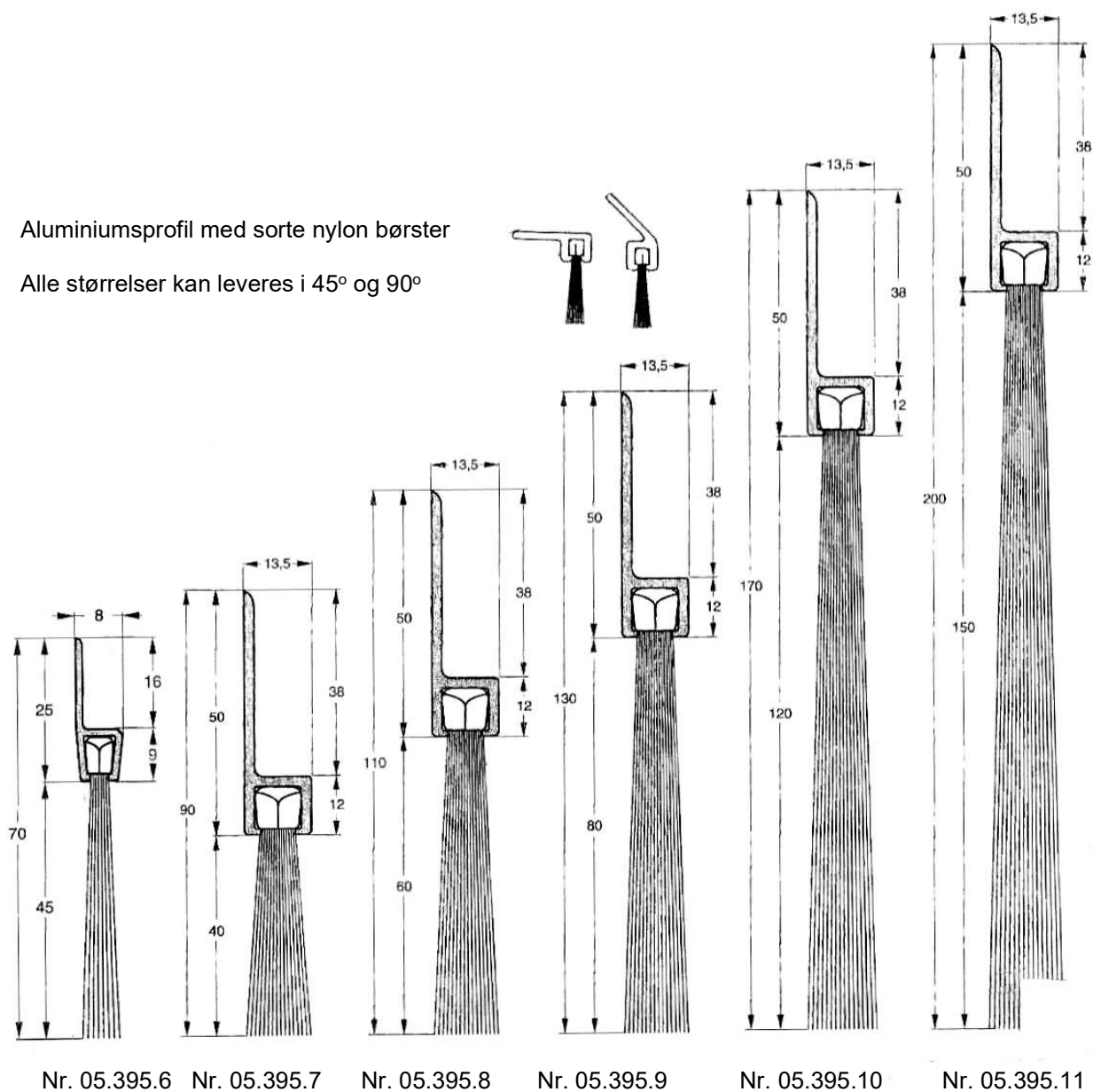
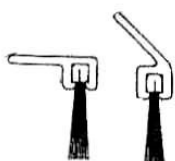



## SLÆBELISTER

Nr. 05.315.00  
EPDM gummi

Nr. 05.315.01  
Eloxeret aluminiums profil

Oplys venligst det ønskede H mål

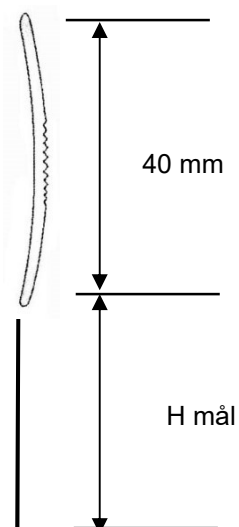

## GUMMISPARKERPLADER

Nr. 05.380 finriflet  
dimension 1200 x 3 mm  
farve grå + sort

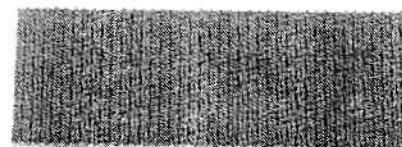

Nr. 05.384 bredriflet  
dimension 1200 x 5 mm  
farve grå + sort

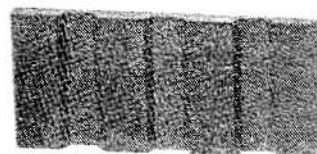



**VIGTIGT\*\*\*VIGTIGT\*\*\*VIGTIGT\*\*\*VIGTIGT\*\*\*VIGTIGT\*\*\*VIGTIGT**

## **Tætningslister fra JØVA BESLAG A/S**

(Gælder kun tætningslister fremstillet i plast)

### **Levering**

Kontroller straks ved modtagelsen om forsendelsen indeholder de rigtige tætningslister i de rigtige mål og antal.

### **Montering**

Vi anbefaler at tætningslister ud pakkes snarest muligt efter levering og opbevares fladt ved almindelig rumtemperatur.

Større tætningslister kan være foldet en enkelt gang af hensyn til transporten. Disse foldes ud, og ligges fladt i minimum 30 minutter inden montage.

Uanset tætningslistens type - **skal hjørnerne fastgøres først.**

Herefter kan tætningslisten fastgøres på siderne og i top og bund.

### **Returret**

Svejste tætningslister fremstillet på mål tage ikke retur.

### **Rengøring**

Tætningslister skal rengøres med jævne mellemrum med rent varmt vand, eventuelt tilsat en smule opvaskemiddel.

Brug eventuelt en blød opvaskebørste.

Listen efter tørres med en tør klud.

Eventuelle mugdannelse kan fjernes med klorin, opløst i varmt vand i forholdet 1 dl klorin pr. 5 L vand.

Brug eventuelt en gammel blød tandbørste for at rengøre alle folderne – husk gummihandsker!

Vask grundigt efter med rent varmt vand.



Madrester, olie og fedt skal **omgående** fjernes, da disse kan **forkorte tætningslistens levetid betydeligt.**

Brug **ALDRIG** benzin, fortynder, sprit eller lignende opløsningsmidler til rengøring af tætningslister.

### **Tætningslister må ikke rengøres i opvaskemaskinen!**

Opbevar venligst denne vejledning i firmaets vedligeholdelses- eller rengøringsmappe til senere brug.

**JØVA BESLAG A/S • Tyttebærvej 4 • 8643 Ans By • Tlf. 8617 2122**  
e-mail: info @joeva.dk • [www.joeva.dk](http://www.joeva.dk)

# Opmålingskema for svejste tætningslister

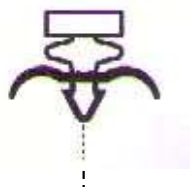

Lister til spor opgives mål fra midt/midt

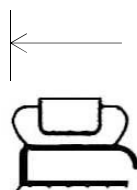

Øvrige lister opgives udvendigt mål

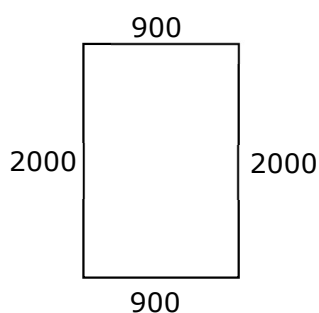

Tætningslister på 4 sider oplyses således:  
900 x 2000 mm (bxh)

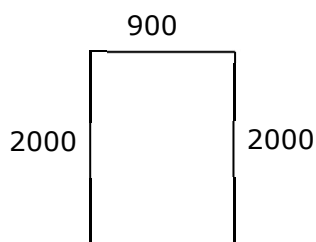

Tætningslister på 3 sider oplyses således:  
2000 x 900 x 2000 mm (bxh)

Hvis der ønskes A-profil i hængselsiden, oplyses der om  
døren er højre eller venstre hængt



**JØVA Beslag A/S**  
Tyttebærvej 4 • DK-8643 Ans By  
Tlf. +45 8617 2122  
[www.joeva.dk](http://www.joeva.dk)  
email: [info@joeva.dk](mailto:info@joeva.dk)